





trinean

Minimized samples,
Maximized throughput

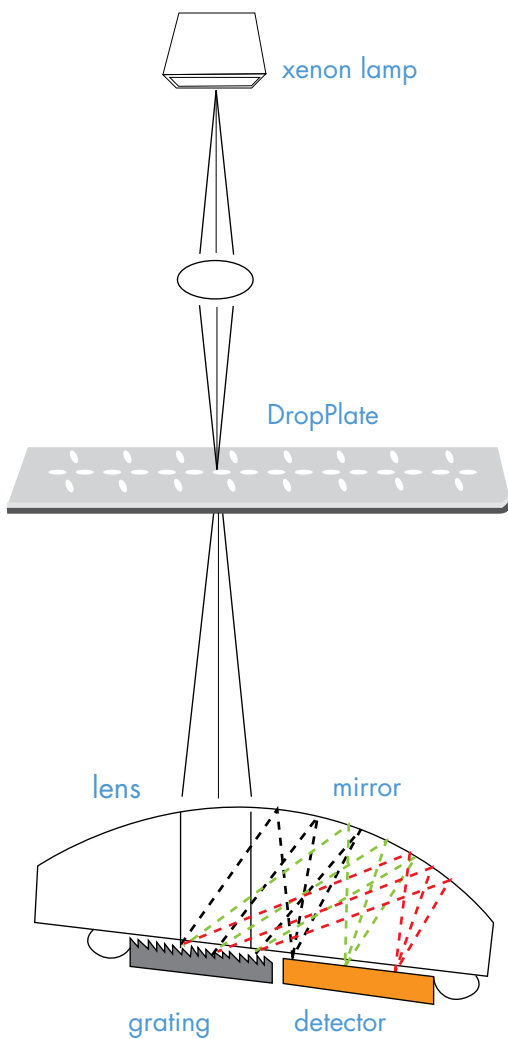

The solution for high throughput
UV-VIS analysis of small droplets



Unique patent pending optical spectrometer design combining cylindrical lenses with integrated optical elements, high resolution gratings and ultrasensitive photodiode array.

DropSense® 96 Polychromatic µl plate reader

- Designed for reading DropPlates 16 and microplates
- UV-VIS absorption spectrometry, perfect fit for biomolecule quantifications
- Full spectrum measurement in seconds
- Multiplex measurements
- Large dynamic range (5-3500 ng/µl dsDNA)
- No need for sample dilution
- Intuitive software, ready to use
- Predefined software for DNA/RNA and protein concentration measurements
- High reproducibility (consumable blank and lamp compensation)

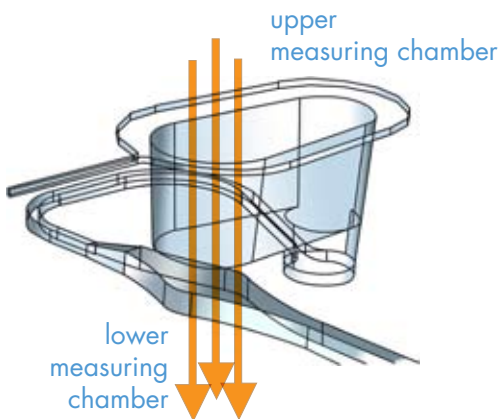
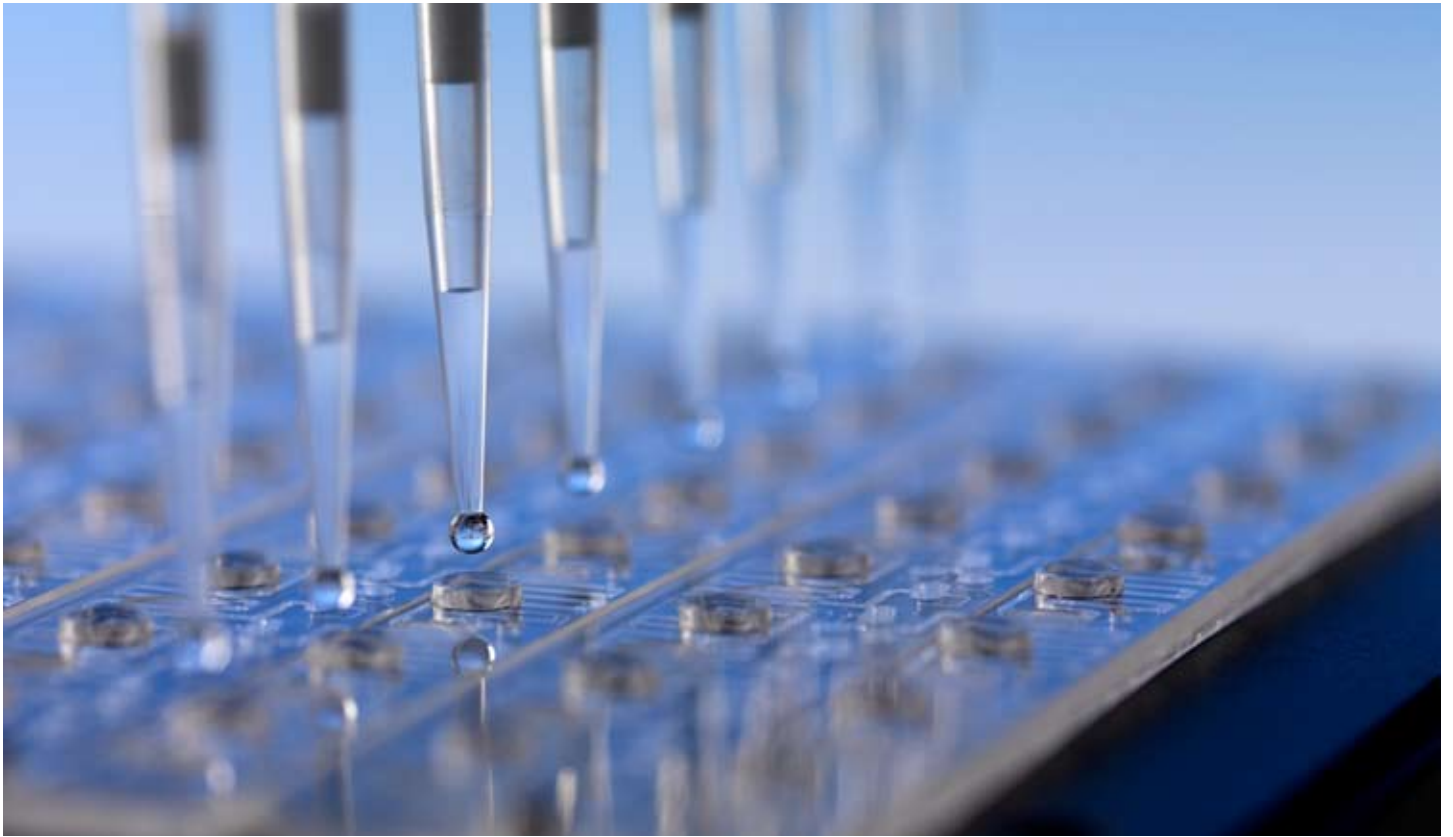

- 1-3 μl sample quantities, minimized sample consumption
- 16 to 96 sample disposable technology, scaling up to high throughput and automation
- Minimized sample evaporation, allowing time and temperature depending assays
- Dynamic range: 5-3500 ng/ μl dsDNA
- No sample dilution needed

DropPlate[®] 16/96

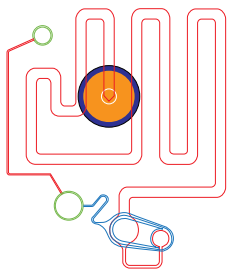

Step 1

Fluid is dispensed into the input well. Dispensing is done manually or via a liquid handling robot. The chip is not in the DropSense system during dispensing.

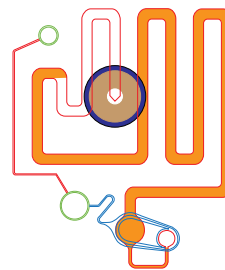

Step 3

First chamber is filled by applying a small vacuum pressure at the evacuation hole above the spill chamber. This pressure is supplied by an external source, integrated in the DropSense system. Another optical measurement is performed.

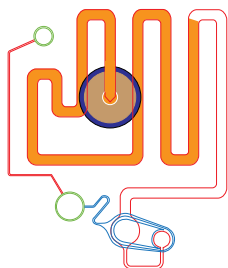

Step 2

Fluid is drawn into the capillary channel due to capillary action. The chip is now ready to be loaded into the system. A first optical measurement will be performed to verify the absorption of the chip material. No sample is yet in the optical pathway.

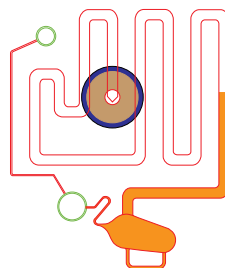

Step 4

Second chamber is also filled by applying a higher vacuum pressure. Another optical measurement is performed through both chambers.

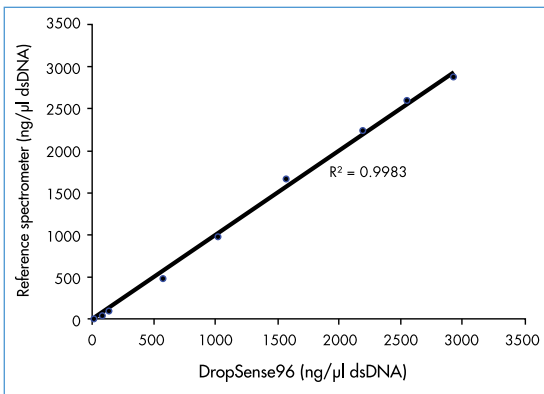

Dynamic range and accuracy of DNA quantification with the DropSense96. A comparative analysis with a commercial microliter spectrometer was performed using dilutions of calf thymus dsDNA (5 - 3000 ng/μL).

Key applications

- Nucleic acids concentration measurements
- Purity calculations
- Measurement of dye labeling efficiency of micro-array samples
- Direct protein quantifications
- Color measurements (e.g. Bradford)
- General UV/VIS measurements

High throughput applications

The DropSense 96 is the first μL microplate reader giving full spectrum scans of 96 samples in less than 6 minutes.

The combination of the patented DropSense 96 and DropPlate 16/96 provides a sensitive tool which can measure up to 96 samples simultaneously from a sample volume as low as 1 μL (single measurements). This technology is compatible with all microplate pipettes, liquid handling devices and robots.

Manual DNA or RNA quantification can now be automated by using standard liquid handling devices. Handling for 96 DNA/RNA readings is limited to 1 minute. DNA/RNA quantification is no longer a bottle-neck in the process. For instance an automated DNA concentration measurement and sample normalization can be performed automatically without manual interference.

Monotone and repetitive work is eliminated which also avoids human errors and need for re-testing samples.

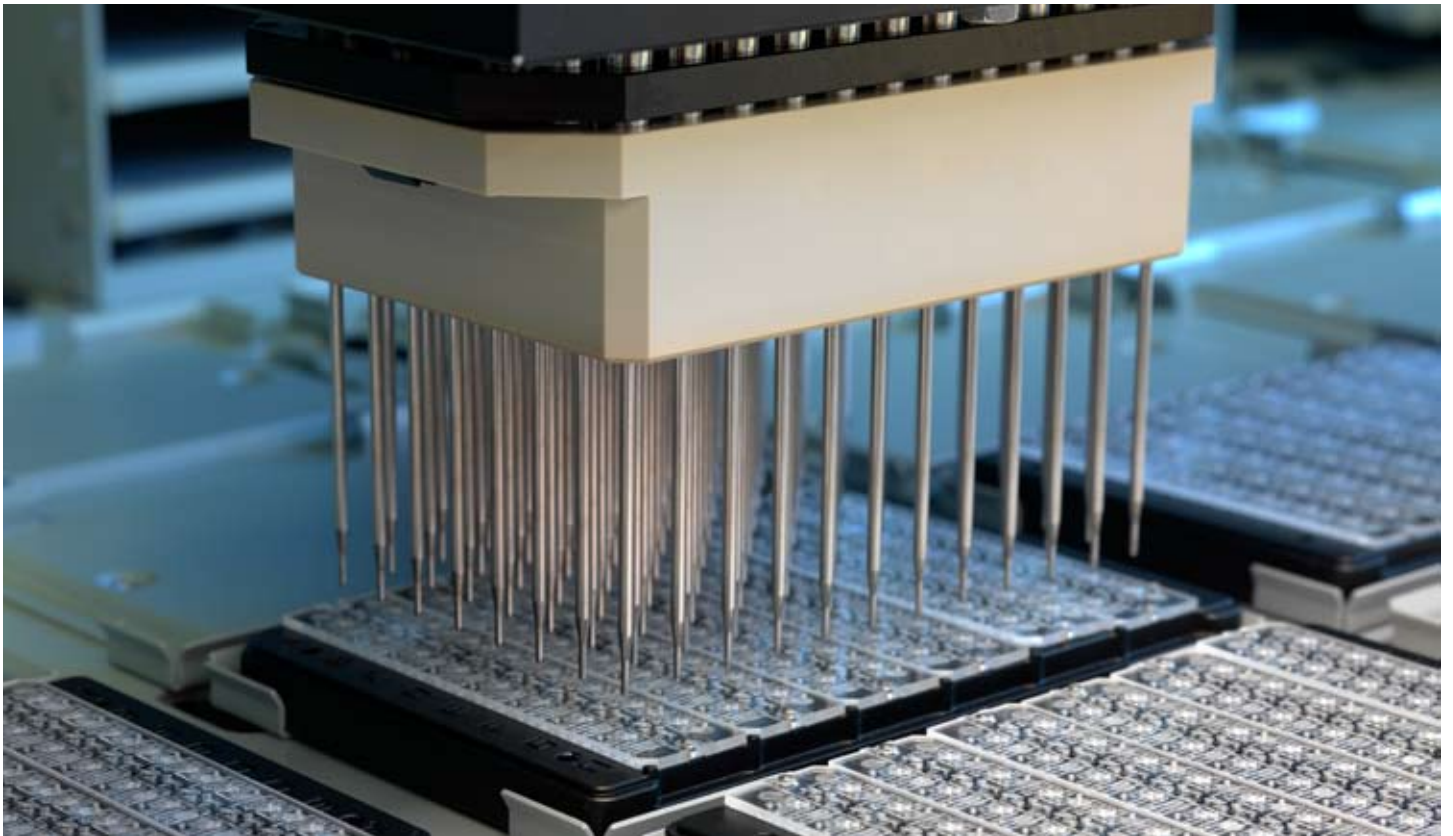

Specifications

Sample size	1 - 3 μ l
Sample number	1 - 16 - 96
Path lengths	0.2 mm and 1 mm
Light source	Xenon flash lamp
Optical system	4-channel polychromator + reference channel
Wavelength range	225 - 750 nm
Wavelength resolution	5 nm
Wavelength accuracy	0,5 nm
Wavelength reproducibility	0,1 nm
Absorbance range	OD 0.05-90 (10 mm equivalent absorbance)
Detection limit	5 ng microliter (dsDNA)
Maximum concentration	3500 ng/microliter (dsDNA)
Measurement cycle time	< 5 minutes for 96 samples (single measurement mode)
Dimensions (footprint)	34 x 45 x 35 cm
Operating voltage	24 VDC
Connection	USB
CE approval	All units

Local dealer

TRINEAN nv
 Dulle Grietlaan 17/3
 B-9050 Gentbrugge
 Belgium
 Phone #32 (0)9 272 7535
www.trinean.com
info@trinean.be